

# ML100ERW Series

## Low Cost, 1W SMT 2:1 Input Range DC/DC Converters



### Key Features:

- 1W Output Power
- 2:1 Input Voltage Range
- 1,500 VDC Isolation
- Compact SMT Case
- 10 Standard Models
- Short Circuit Protected
- -40°C to +85°C Operation
- Available On Tape/Reel
- Board Mount Version Avail.
- Low Cost



### MicroPower Direct

292 Page Street  
Suite D  
Stoughton, MA 02072  
USA

T: (781) 344-8226

F: (781) 344-8481

E: sales@micropowerelectronics.com

W: www.micropowerelectronics.com



### Electrical Specifications

Specifications typical @ +25°C, nominal input voltage & rated output current, unless otherwise noted. Specifications subject to change without notice.

Input						
Parameter	Conditions	Min.	Typ.	Max.	Units	
Input Voltage Range	12 VDC Input	9.0	12.0	18.0	VDC	
	24 VDC Input	18.0	24.0	36.0		
Input Start Voltage	12 VDC Input			9.0	VDC	
	24 VDC Input			18.0		
Reflected Ripple Current	12 VDC Input		40		mA	
	24 VDC Input		55			
Input Filter	Capacitor					
Output						
Parameter	Conditions	Min.	Typ.	Max.	Units	
Output Voltage Accuracy	I <sub>OUT</sub> = 5% to 100%		±1.0	±3.0	%	
No Load Output Voltage Accuracy	3.3 VDC Output		±5.0	±8.0	%	
	All Other Outputs		±1.5	±5.0	%	
Line Regulation	V <sub>IN</sub> = Min to Max		±0.2	±0.5	%	
Load Regulation	I <sub>OUT</sub> = 5% to 100%		±0.5	±1.0	%	
Ripple & Noise (20 MHz)	See Note 1		50	100	mV Pk-Pk	
Transient Recovery Time, See Note 2	25% Load Step Change		0.5	3.0	mSec	
Transient Response Deviation			±2.5	±5.0	%	
Temperature Coefficient			±0.02	±0.03	% / °C	
Output Short Circuit, See Note 3	Continuous (Autorecovery)					
General						
Parameter	Conditions	Min.	Typ.	Max.	Units	
Isolation Voltage, See Note 4	60 Seconds	1,500			VDC	
Isolation Resistance	500 VDC	1,000			MΩ	
Isolation Capacitance	100 kHz, 0.1V		100		pF	
Switching Frequency			300		kHz	
Environmental						
Parameter	Conditions	Min.	Typ.	Max.	Units	
Operating Temperature Range	Ambient	-40	+25	+85	°C	
Storage Temperature Range		-55		+125	°C	
Cooling	Free Air Convection					
Humidity	RH, Non-condensing			95	%	
Physical						
Case Size	See Mechanical Drawing (Page 4)					
Case Material	Non-Conductive Black Plastic (UL94-V0)					
Weight	See Mechanical Drawing (Page 4)					
Reliability Specifications						
Parameter	Conditions	Min.	Typ.	Max.	Units	
MTBF	MIL HDBK 217F, 25°C, Gnd Benign	1.0			MHours	
Absolute Maximum Ratings						
Parameter	Conditions	Min.	Typ.	Max.	Units	
Input Voltage Surge (1 Sec)	12 VDC Input			25.0	VDC	
	24 VDC Input			50.0		
Peak Reflow Temperature	See Note 5			240	°C	
Lead Temperature	1.5 mm From Case for 10 Sec			300	°C	

Caution: Exceeding Absolute Maximum Ratings may damage the module. These are not continuous operating ratings.

[www.micropowerelectronics.com](http://www.micropowerelectronics.com)

Model Number	Input				Output			Efficiency (% Typ)	Capacitive Load ( $\mu\text{F}$ Max)	Fuse Rating Slow-Blow (mA)
	Voltage (VDC)		Current (mA)		Voltage (VDC)	Current (mA, Max)	Current (mA, Min)			
	Nominal	Range	Full-Load	No-Load						
ML112S-03ERW	12	9.0 - 18.0	111	30	3.3	303	0.0	75	2,700	300
ML112S-05ERW	12	9.0 - 18.0	111	30	5.0	200	0.0	77	2,200	300
ML112S-12ERW	12	9.0 - 18.0	111	30	12.0	83	0.0	79	1,000	300
ML112S-15ERW	12	9.0 - 18.0	111	30	15.0	67	0.0	80	680	300
ML112S-24ERW	12	9.0 - 18.0	111	30	24.0	42	0.0	76	470	300
ML124S-03ERW	24	18.0 - 36.0	55	20	3.3	303	0.0	75	2,700	150
ML124S-05ERW	24	18.0 - 36.0	55	20	5.0	200	0.0	77	2,200	150
ML124S-12ERW	24	18.0 - 36.0	55	20	12.0	83	0.0	78	1,000	150
ML124S-15ERW	24	18.0 - 36.0	55	20	15.0	67	0.0	78	680	150
ML124S-24ERW	24	18.0 - 36.0	55	20	24.0	42	0.0	77	470	150

**Notes:**

1. When measuring output ripple & noise, it is recommended that external ceramic capacitors (approx 1  $\mu\text{F}$  & 10  $\mu\text{F}$ ) be placed from the +Vout to the -Vout pins.
2. Transient recovery is measured too within a 1% error band for a load step change of 25%.
3. Short circuit protection is provided by a "hiccup mode" circuit.
4. Isolation voltage is specified for a period 60S with a leakage current lower than 1 mA.
5. The recommended reflow settings are a peak temperature of 240 °C for a maximum period (TPK) of 10S and a time above liquidous (TL) of  $\leq 60$  seconds at 217 °C. A suggested temperature profile is shown below. For more information, please contact the factory.
6. It is recommended that a fuse be used on the input of a power supply for protection. See the Model Selection table above for the correct rating.

**Temperature Derating Curve**

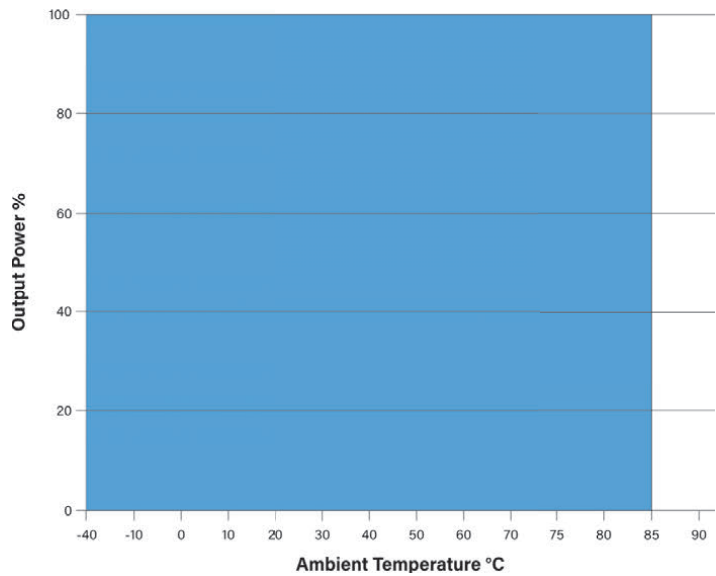

**Reflow Solder Settings**

The ML100xERW series is designed to meet the IPC/JEDEC standard J-STD-020D for reflow soldering. The recommended reflow settings are a peak temperature of 245 °C for a maximum period (TPK) of 10S and a time above liquidous (TL) of  $\leq 60$  seconds at 217 °C, as illustrated above. For more information, please contact the factory.

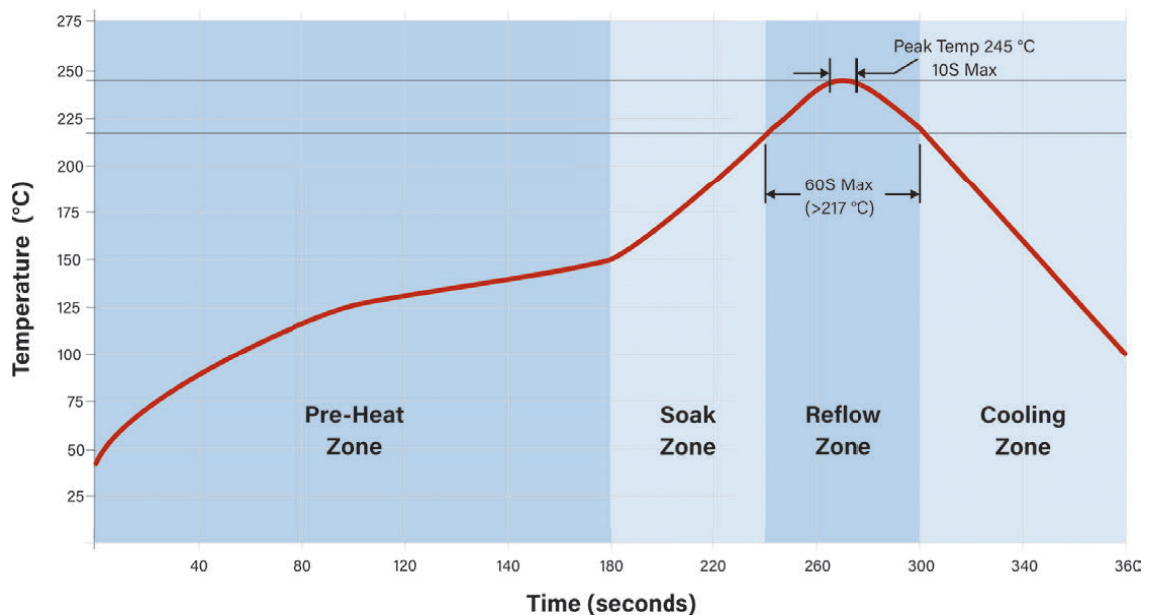



The diagram above illustrates a simple connection of the ML100ERW series. For applications that do not require the circuit to meet EMI/EMC specifications, the input filter consisting of capacitors C1 & C2 and the inductor LDM1 will reduce input/output ripple and improve the converter stability over time and temperature. The recommended component values are given in the table at right.

VIN	Fuse	C1	LDM1	C2	C3
12 VDC	250 mA	100 $\mu$ F/25V	4.7 $\mu$ H To	47 $\mu$ F/50V	100 $\mu$ F
24 VDC	120 mA	10 $\mu$ F/50V	12 $\mu$ H	1 $\mu$ F/25V	100 $\mu$ F

EMC Specifications

Parameter	Standard	Criteria	Level
Radiated Emissions	See Note 1	EN 55032	Class B
Conducted Emissions	See Note 1	EN 55032	Class B
ESD		EN 61000-4-2	B $\pm$ 4 kV Contact
RS		EN 61000-4-3	A 10V/m
EFT	See Note 2	EN 61000-4-4	B $\pm$ 2 kV
Surge	See Note 3	EN 61000-4-5	B $\pm$ 2 kV L - L
CS		EN 61000-4-6	A 3 Vrms

Notes:

1. If the application does not require that emissions meet international standards, simply adding capacitors to the input and output circuits may be sufficient to reduce ripple & noise. See note above.
2. To meet the requirements of EN 61000-4-4, external components are needed. The connection diagram below shows an external input filter that would typically achieve this. Contact the factory for more information.
3. To meet the requirements of EN 61000-4-5, external components are needed. This can be done as shown in the connection diagram below. Contact the factory for more information.

Typical Connection

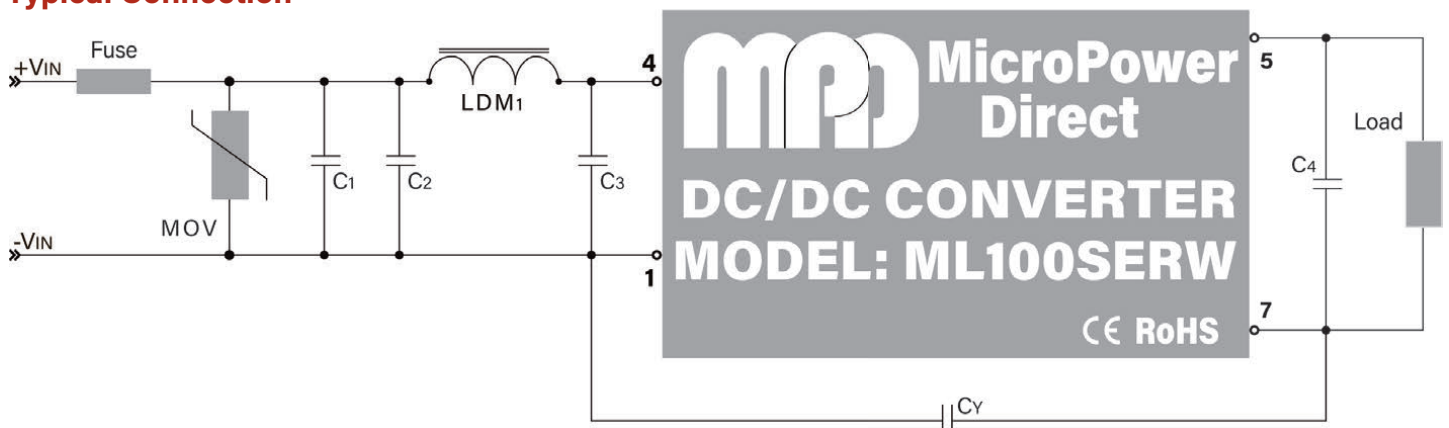

The diagram above illustrates a typical connection of the ML100ERW series for an application that requires compliance to EMI/EMC standards EN 55032 and EN 61000-4 (as specified above). Some notes on these components are:

1. An external fuse is recommended to protect the unit in the event of a fault on the input line. A recommended value is given in model selection table on page 2.
2. The output filtering capacitor (C4) is a high frequency, low resistance electrolytic capacitor. Care must be taken in choosing this capacitor not to exceed the capacitive load specification for the unit. Voltage

derating of capacitors should be 80% or above.

3. Suggested component values are:

Component	VIN: 12V	VIN: 24V
MOV	14D330K	20D470K
C1	680 $\mu$ F/25V	330 $\mu$ F/50V
C2	4.7 $\mu$ F/50V	4.7 $\mu$ F/50V
L1	12 $\mu$ H	12 $\mu$ H
C3	4.7 $\mu$ F/50V	4.7 $\mu$ F/50V
CY	---	1 nF/2 kV
C4	100 $\mu$ F	100 $\mu$ F

4. In many applications, simply adding a simple input filter and output capacitor will enhance the input protection & and reduce output ripple sufficiently. In this case, the unit could be connected as shown in the simple connection above, without the other filter components. Recommended capacitor values are given in the table above.

**Mechanical Dimensions**

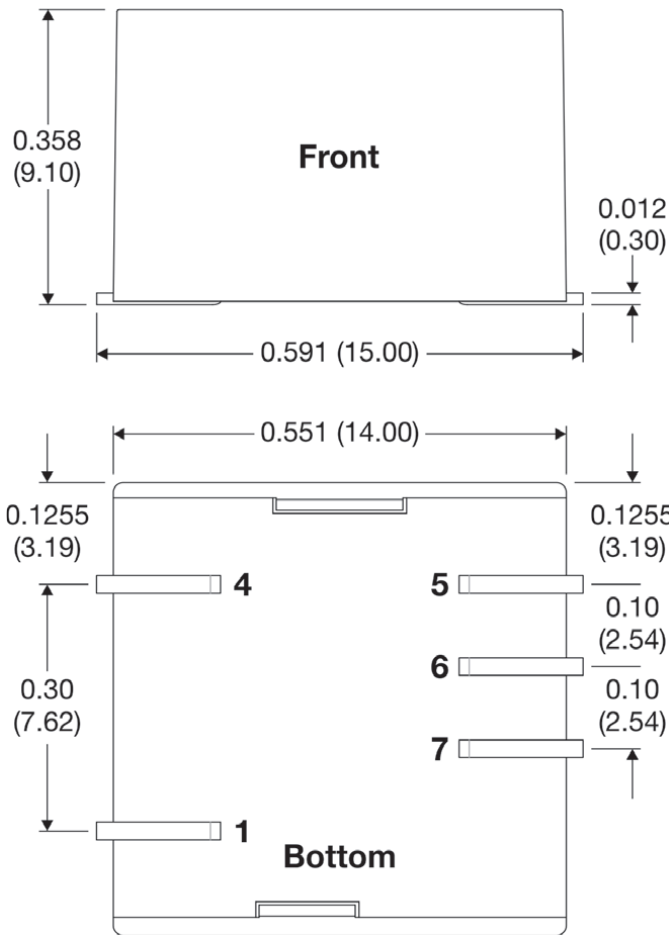

**Pin Connections**

Pin	Function
1	-VIN
4	+VIN
5	+VOUT
6	No Connection
7	-VOUT

**Notes:**

- All dimensions are typical in inches (mm)
- Pin 1 is marked by a "dot" or indentation on the unit
- General Tolerance = ±0.02 (±0.50)
- Pin Tolerance = ±0.004 (±0.10)
- Weight (Typ) = 0.077 Oz (2.2g)

**Board Solder Pad Layout**

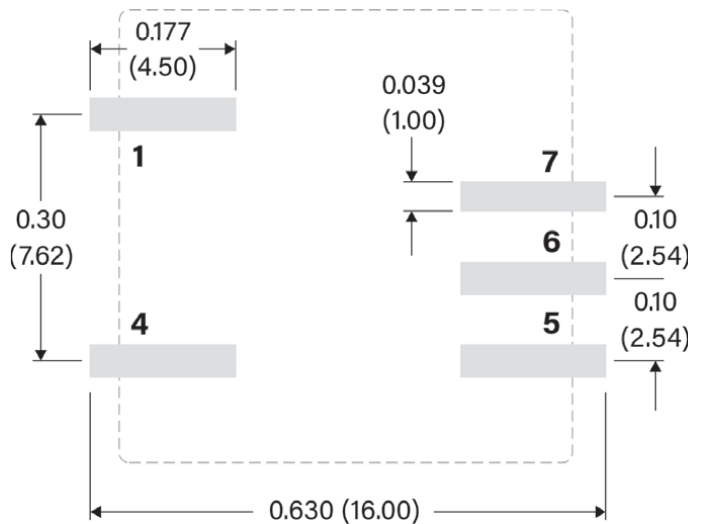

**Also Available: MH100ERW Series**



The ML100ERW series is also available in a miniature board-mount package. The MH100ERW series offers the same performance specifications and a package that also delivers tremendous space savings.

**Reel Dimensions**

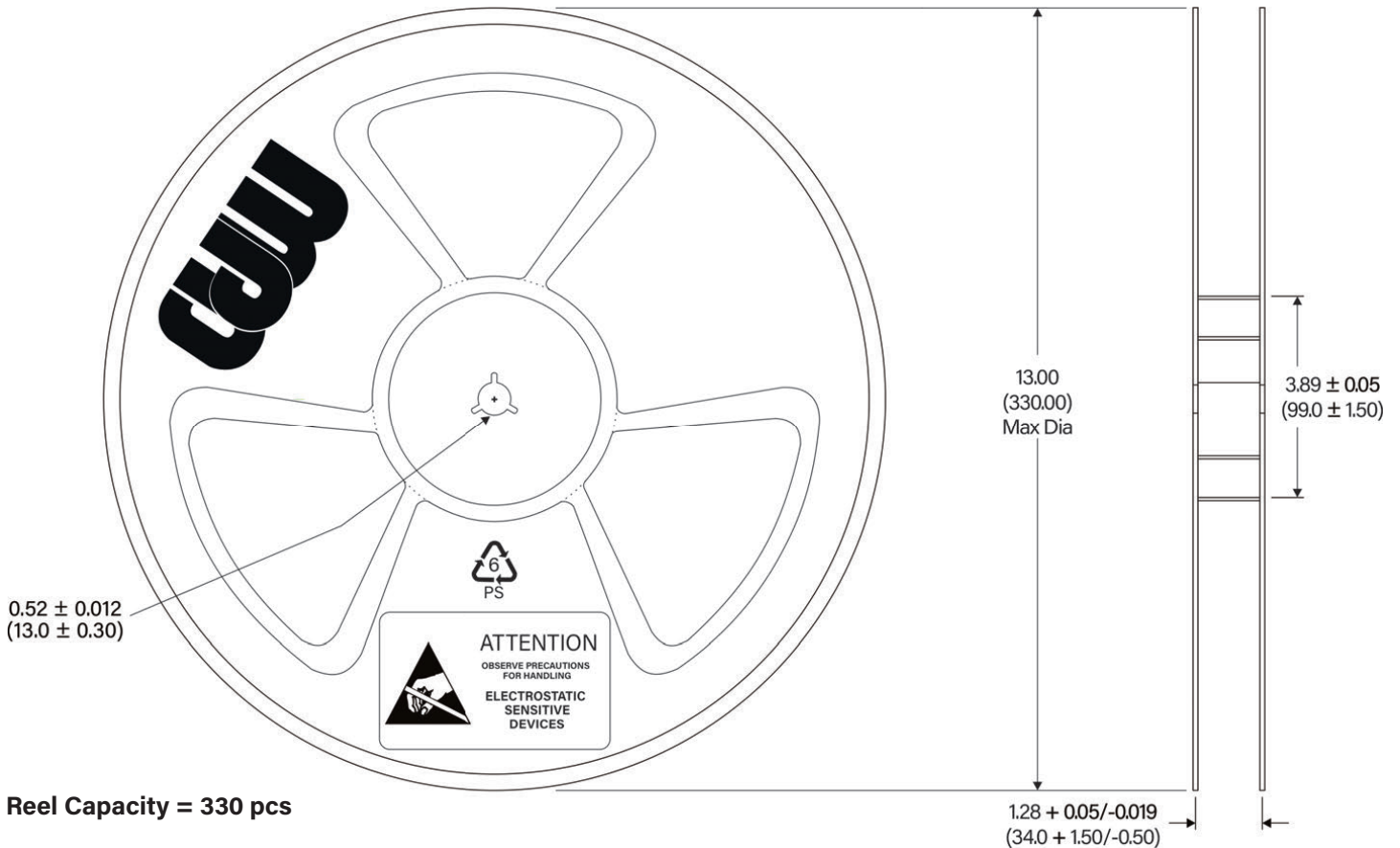

**Reel Capacity = 330 pcs**

**Tape Dimensions**

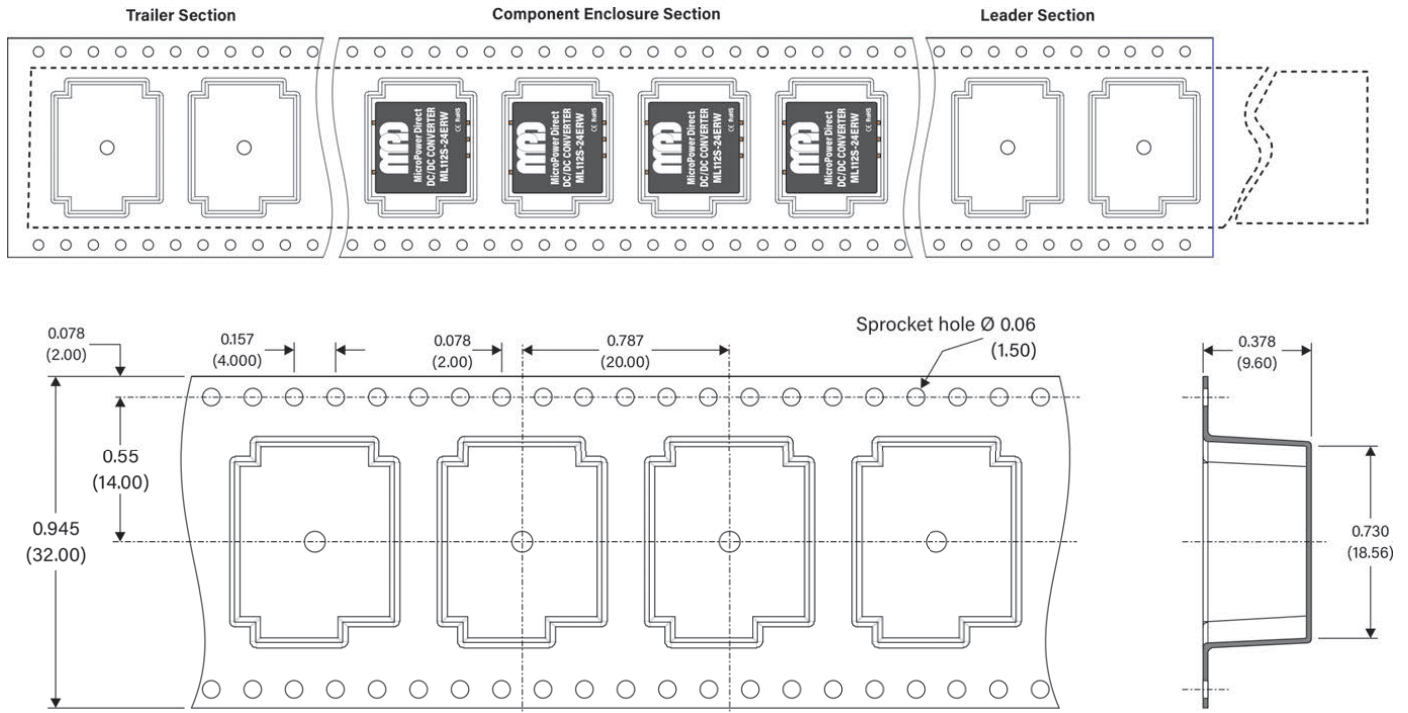

All ML100ERW reels are sealed in moisture barrier packaging. Any units that are not packaged in a vacuum sealed container should be stored in a controlled environment. Contact the factory for more information.