

# MDCFM-40U



## 40V-160VDC Input, Compact EMC Filter Module

### Key Features:

- 40 to 110 VDC Input
- Compact 1" x 2" Case
- Meets EN 50155
- Reverse Polarity Protection
- 1.2 MHour MTBF
- -40°C to +85°C Operation
- 98% Efficiency
- Chassis Mount Option
- DIN Rail Mount Option
- Low Cost



### Electrical Specifications

Specifications typical @ +25°C, nominal input voltage & rated output current, unless otherwise noted. Specifications subject to change without notice.

Parameter	Conditions	Min.	Typ.	Max.	Units
Input Voltage Range, See Note 1		40		160	VDC
No Load Current, See Note 2	MDCFM-40U-10, MDCFM-40U-30			1.0	mA
	MDCFM-40U-50			3.0	

### General

Parameter	Conditions	Min.	Typ.	Max.	Units
Efficiency	MDCFM-40U-10		95		%
	MDCFM-40U-30, MDCFM-40U-50		98		
Max Output Voltage			165		VDC
Max Output Power	MDCFM-40U-10			10	W
	MDCFM-40U-30			30	
	MDCFM-40U-50			50	

### EMI Characteristics (See Note 4)

Parameter	Standard	Level
Radiated Emissions	EN 55022	Class B (150 kHz - 30 MHz)
Conducted Emissions	EN 55022	Class B (30 MHz - 1 GHz)
ESD	EN 61000-4-2	Criteria B; Air ±8 kV, Contact ±6 kV
RS	EN 61000-4-3	Criteria A; 10V/m
EFT	EN 61000-4-4	Criteria B; ±4 kV (5 kHz - 100 kHz)
Surge	EN 61000-4-5	Criteria B; ±2 kV (1.2 μS/50 μS 2Ω) Criteria B; ±4 kV (1.2 μS/50 μS 12Ω)
CS	EN 61000-4-6	Criteria B; 10 Vrms
Vibration	EN 61373	Sinusoidal 5~150 Hz; 7.5 mm Amplitude; 10g Acceleration

### Environmental

Parameter	Conditions	Min.	Typ.	Max.	Units
Operating Temperature Range	Ambient	-40	+25	+85	°C
Storage Temperature Range		-55		+125	°C
Cooling	Free Air Convection				
Humidity	RH, Non-condensing			95	%

### Physical

Case Size	Module	See Mechanical Drawing (Page 2)
	Chassis (A2) Mount	See Mechanical Drawing (Page 2)
	DIN (A4) Mount	See Mechanical Drawing (Page 2)
Case Material	Non-Conductive Black Plastic (UL94-V0)	
Weight	Module	1.77 Oz (50g)
	Chassis (A2) Mount	2.48 Oz (70g)
	DIN (A4) Mount	3.19 Oz (90g)

### MicroPower Direct

292 Page Street  
Suite D  
Stoughton, MA 02072  
USA

T: (781) 344-8226

F: (781) 344-8481

E: sales@micropowerdirect.com

W: www.micropowerdirect.com



[www.micropowerdirect.com](http://www.micropowerdirect.com)

Model Number	Input Voltage Range (VDC)		Withstand Voltage (VAC)	Max. Output Power (W)	Efficiency (%)
	Nominal	Range			
MDCFM-40U-10	110	40 - 160	500	10	95%
MDCFM-40U-30	110	40 - 160	500	30	98%
MDCFM-40U-50	110	40 - 160	1,500	50	98%

**Notes:**

1. The Max input voltage level of the DC/DC converter must be less than the maximum specified input of the **MDCFM-40U**.
2. The maximum power of the DC/DC converter must be less than the maximum output power of the **MDCFM-40**.
3. The -Vout pin should not be connected to the "ground" input.

**Typical Connection**

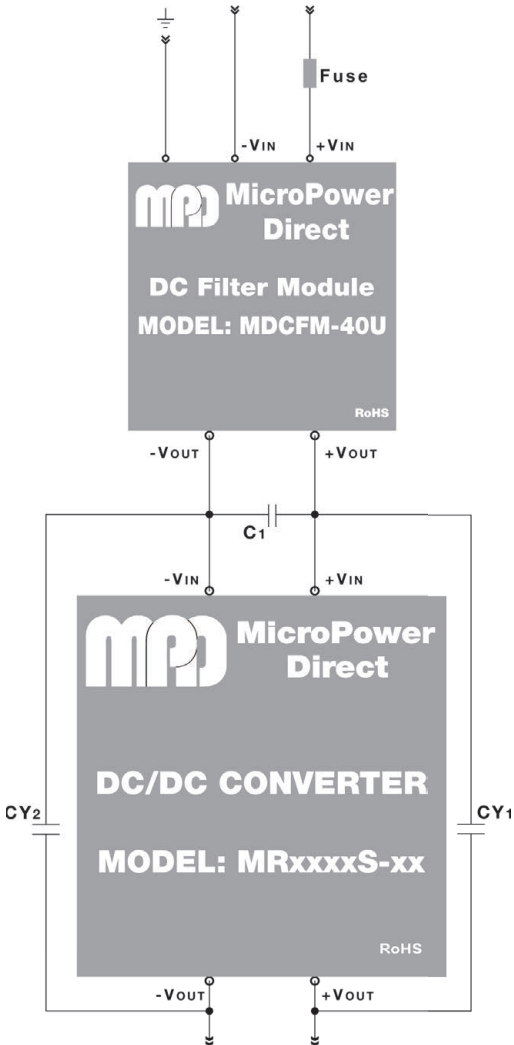

The diagram at right shows a typical connection for a **MDCFM-40U** series filter module. Praying at right i The external capacitors shown in the typical connection diagram below are required to meet specified operation. Recommended component values are given in the table below.

Component	Value
C <sub>1</sub>	400 $\mu$ F/200V
CY <sub>1</sub> , CY <sub>2</sub>	1nF/2 kV

The "GND" input should not be connected to the -Vin pin or the -Vout pin of the filter. Also, the Y capacitors should be connected as shown, not from the filter module input to the DC/DC module output.

**Efficiency vs Input Voltage (Full Load)**

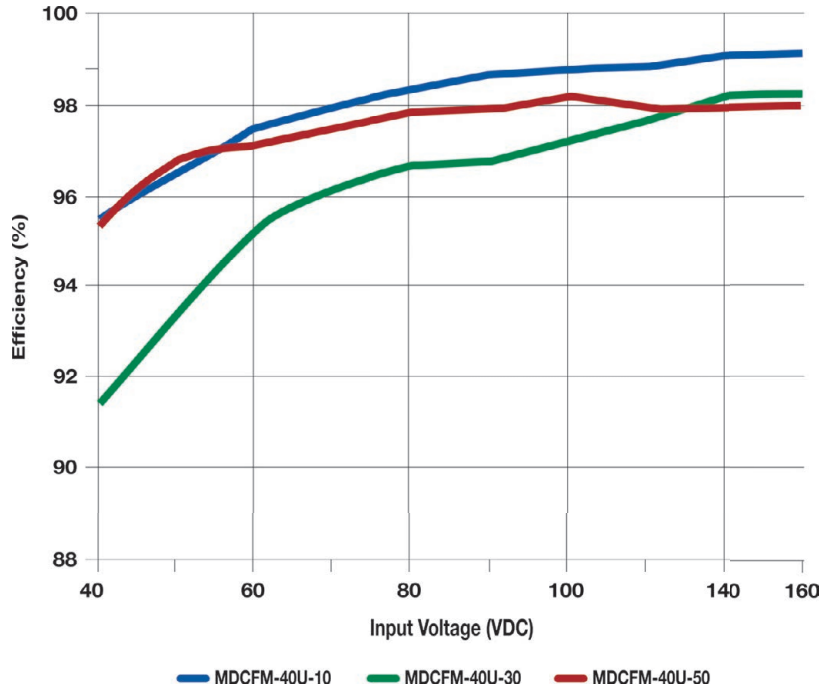

**Efficiency vs Output Power (VIN= 110 VDC)**

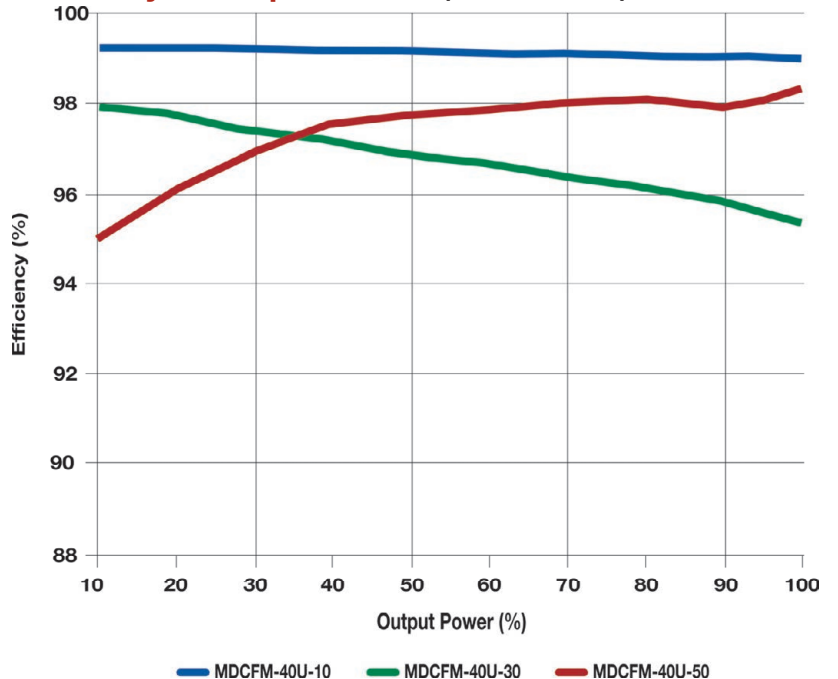

**Mechanical Dimensions, MDCFM-40U-10**

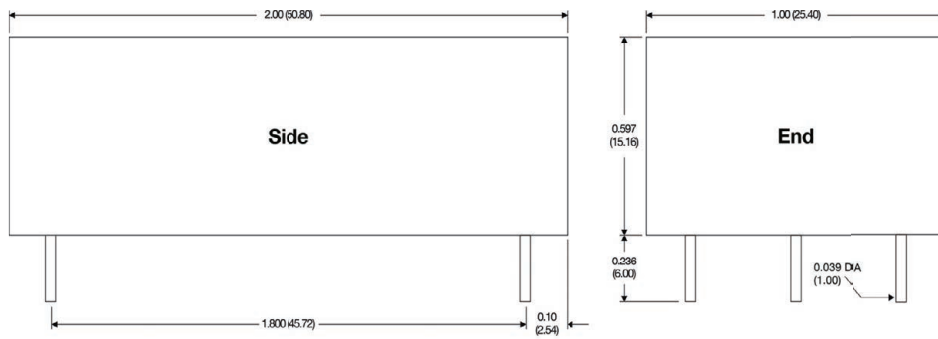

**Pin Connections**

Pin	Function
1	GND
2	-VIN
3	+VIN
4	+VOUT
5	-VOUT

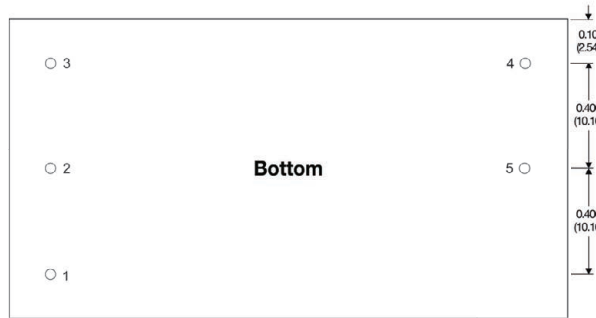

**Mechanical Dimensions: With Chassis Mount Option (A2)**

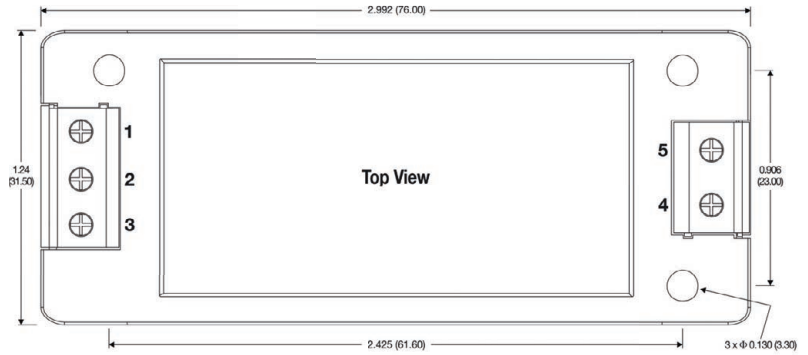

**Mechanical Dimensions: With DIN Rail Option (A4)**

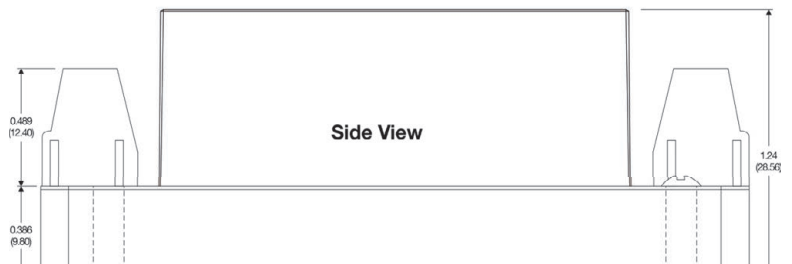
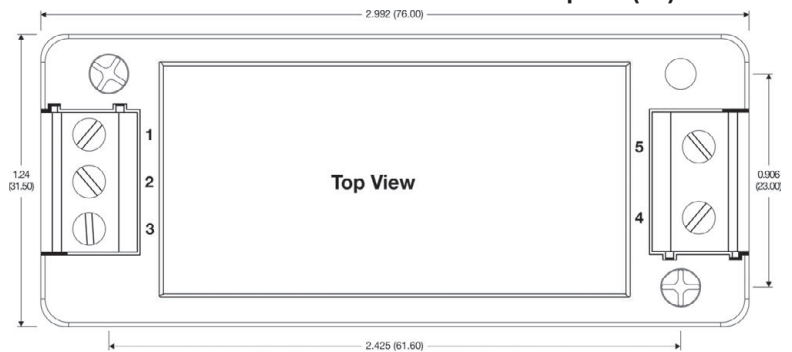

The **MDCFM-40U-10** is available mounted on an adapter plate for mounting to a chassis or on a DIN rail. Mechanical dimensions for these adapters is shown at right. The photo below shows a product mounted on a similar adapter. Please contact the factory for more information.

For the chassis mount option, add suffix "A2" to the model number (i.e. **MDCFM-40U-10-A2**)

For the DIN rail mount option, add suffix "A4" to the model number (i.e. **MDCFM-40U-10-A4**)

**Pin Connections**

Pin	Function
1	GND
2	-VIN
3	+VIN
4	+VOUT
5	-VOUT

Connection is the same for A2 & A4



**Notes:**

- All dimensions are typical in inches (mm)
- Tolerance x.xx = ±0.02 (±0.50)
- Wire range for A2 & A4 connection is 24 - 12 AWG

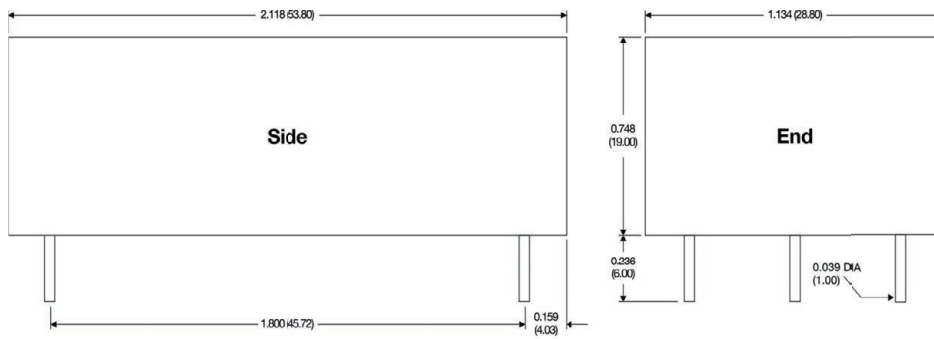

### Pin Connections

Pin	Function
1	GND
2	-VIN
3	+VIN
4	+VOUT
5	-VOUT

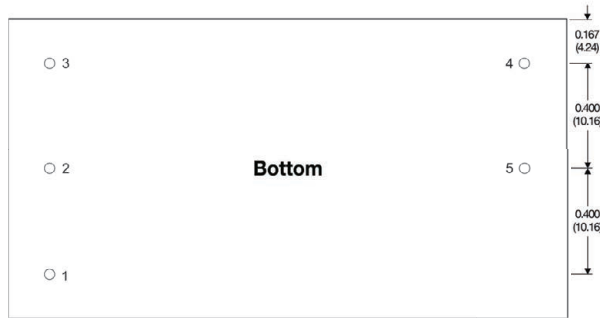

### Mechanical Dimensions: With Chassis Mount Option (A2)

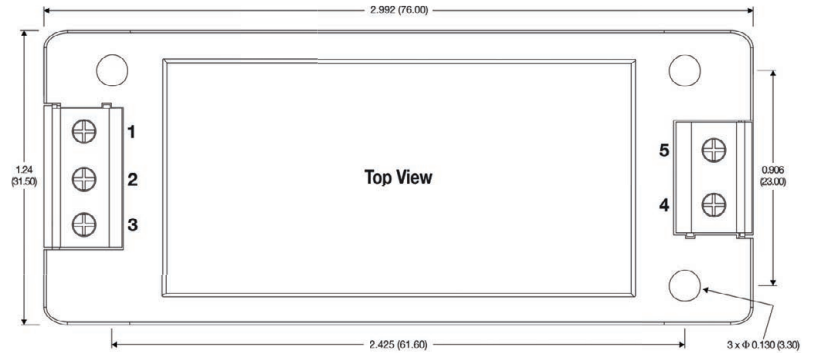

The **MDCFM-40U-30/50** are available mounted on an adapter plate for mounting to a chassis or on a DIN rail. Mechanical dimensions for these adapters are shown at right. The photo below shows a product mounted on a similar adapter. Please contact the factory for more information.

For the chassis mount option, add suffix "A2" to the model number (i.e. **MDCFM-40U-30-A2**)

For the DIN rail mount option, add suffix "A4" to the model number (i.e. **MDCFM-40U-50-A4**)

### Pin Connections

Pin	Function
1	GND
2	-VIN
3	+VIN
4	+VOUT
5	-VOUT

Connection is the same for A2 & A4



### Mechanical Dimensions: With DIN Rail Option (A4)

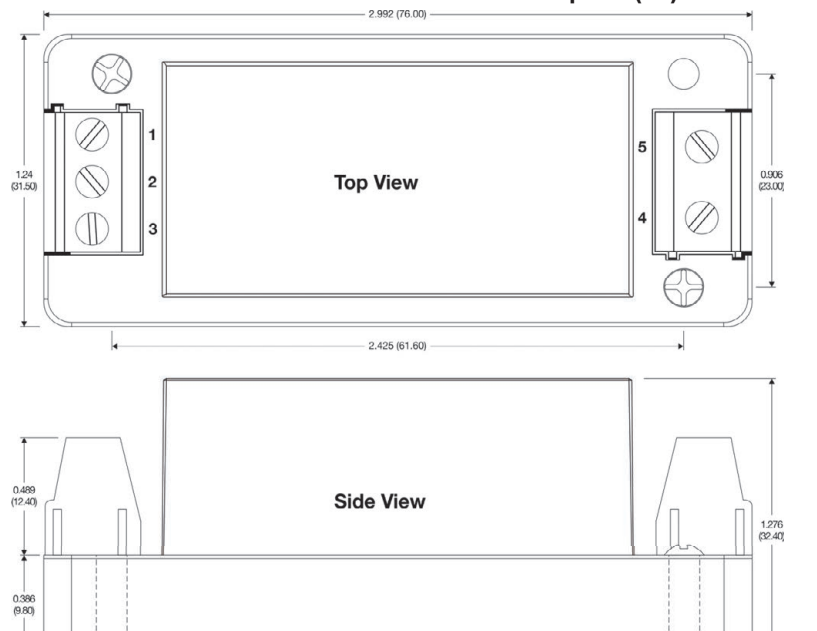

### Notes:

- All dimensions are typical in inches (mm)
- Tolerance x.xx = ±0.02 (±0.50)
- Wire range for A2 & A4 connection is 24 - 12 AWG



**MicroPower Direct**  
We Power Your Success - For Less!