

# MSC215-18

## Compact, 3.5 kV ISO SiC MOSFET Driver DC/DC Converter



### Key Features:

- +15 VDC Input
- +18/-3 VDC Outputs
- 83% Efficiency
- -40°C to 105°C Operation
- 3,500 VAC Isolation
- Low Isolation Capacitance
- Miniature SIP Case
- >3.5 MHour MTBF
- Short Circuit Protection
- Industry Standard Pin-Out

RoHS



### Electrical Specifications

Specifications typical @ +25°C, nominal input voltage & rated output current, unless otherwise noted. Specifications subject to change without notice.

#### Input

Parameter	Conditions	Min.	Typ.	Max.	Units
Supply Voltage Range		See Model Selection Guide			
Input Filter		Internal Capacitor			

#### Output

Parameter	Conditions	Min.	Typ.	Max.	Units
Line Regulation, See Note 1			±1.1	±1.3	%
Load Regulation, See Note 2	18 V <sub>OUT</sub>		5.0	8.0	%
	-3 V <sub>OUT</sub>		10.0	15.0	
Ripple (20 MHz)	See Note 3		60		mV P - P
Noise			75		
Capacitive Load				220	μF
Efficiency		79	83		%
Temperature Coefficient				±0.03	%/°C
Output Short Circuit		Continuous (Autorecovery)			

#### General

Parameter	Conditions	Min.	Typ.	Max.	Units
Isolation Voltage	60 Seconds	3,500			VAC
Isolation Resistance	500 VDC	1,000			MΩ
Isolation Capacitance	100 kHz/0.1V		3.5		pF
Switching Frequency			95		kHz

#### EMI Characteristics

Parameter	Standard	Criteria	Level
Radiated Emissions, See Note 4	EN 55022		Class B
Conducted Emissions, See Note 4	EN 55022		Class B
ESD	EN 61000-4-2	B	±6 kV Contact

#### Environmental

Parameter	Conditions	Min.	Typ.	Max.	Units
Operating Temperature Range	Ambient	-40	+25	+105	°C
Storage Temperature Range		-55		+125	°C
Cooling		Free Air Convection			
Humidity	RH, Non-condensing			95	%

#### Physical

Case Size	See Mechanical Diagram (Page 4)				
Case Material	Non-Conductive Black Plastic (UL94-V0)				
Weight	0.148 Oz (4.2g)				

#### Reliability Specifications

Parameter	Conditions	Min.	Typ.	Max.	Units
MTBF	MIL HDBK 217F, 25°C, Gnd Benign	3.5			MHours

#### Absolute Maximum Ratings

Parameter	Conditions	Min.	Typ.	Max.	Units
Max Supply Voltage (1 Sec)				21	VDC
Lead Temperature	1.5 mm From Case For 10 Sec			300	°C

**Caution:** Exceeding Absolute Maximum Ratings may damage the module. These are not continuous operating ratings.

### MicroPower Direct

292 Page Street  
Suite D  
Stoughton, MA 02072  
USA

T: (781) 344-8226

F: (781) 344-8481

E: sales@micropowerdirect.com

W: www.micropowerdirect.com



[www.micropowerdirect.com](http://www.micropowerdirect.com)

Model Number	Input (Supply)				Output 1					Output 2					Fuse Rating Slow-Blow (mA)
	Voltage (VDC)		Current (mA)		Voltage (VDC)			Current (mA)		Voltage (VDC)			Current (mA)		
	Nom.	Range	Full Load	No Load	Min.	Nom.	Max.	Max	Min	Min.	Nom.	Max.	Max	Min	
MSC215-18	15	13.50 - 16.50	193	16	17.7	18.0	18.45	100.0	10.0	-2.9	-3.00	-3.10	-100.0	-10.0	400

**Notes:**

1. Line regulation is measured for an input voltage change of  $\pm 10\%$ .
2. Load regulation is measured from 10% load to full load.
3. When measuring output ripple & noise, it is recommended that an external capacitor ( $1 \mu F$  to  $10 \mu F$ ) be placed from each output to common.
4. The unit will meet the radiated and conducted EMI specifications with the addition of external components as shown in the connection diagram on page 3. These components are shown inside the dotted line box at the bottom of the illustration
5. Operation at no-load will not damage these units. However, they may not meet all specifications.
6. It is recommended that a fuse be used on the input of a power supply for protection. See the Model Selection table above for the correct rating.

**Derating Curve**

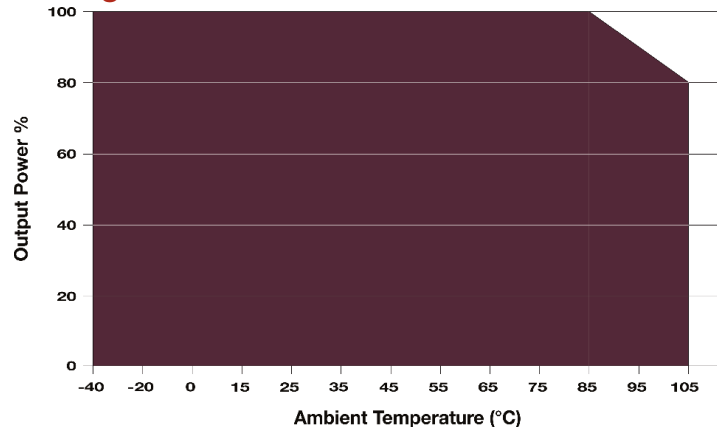

**Efficiency vs Input Voltage**

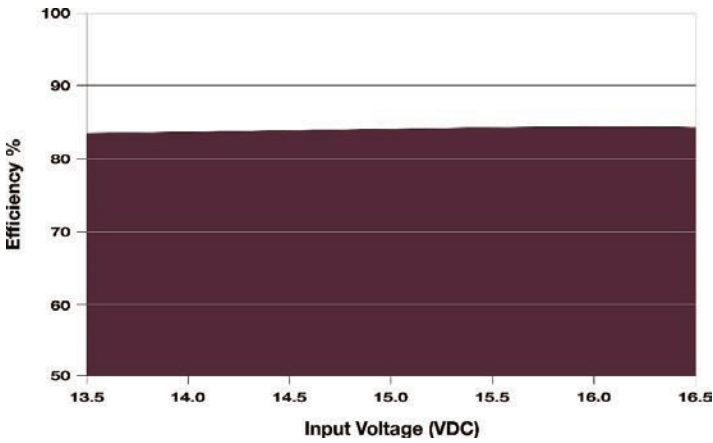

**Efficiency vs Output Load**

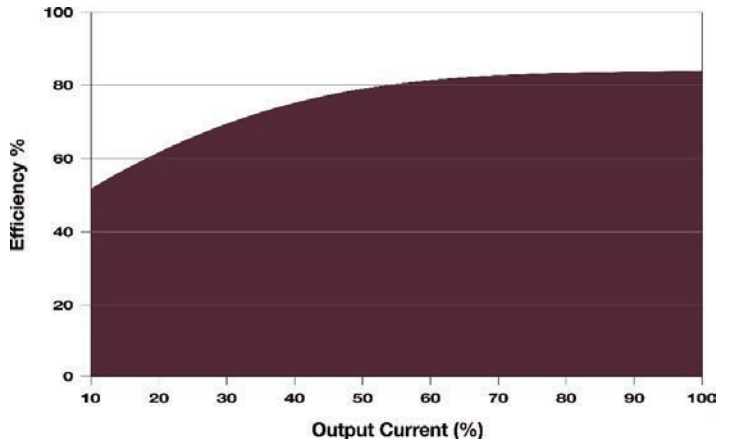

**Output Voltage Tolerance: Positive Output**

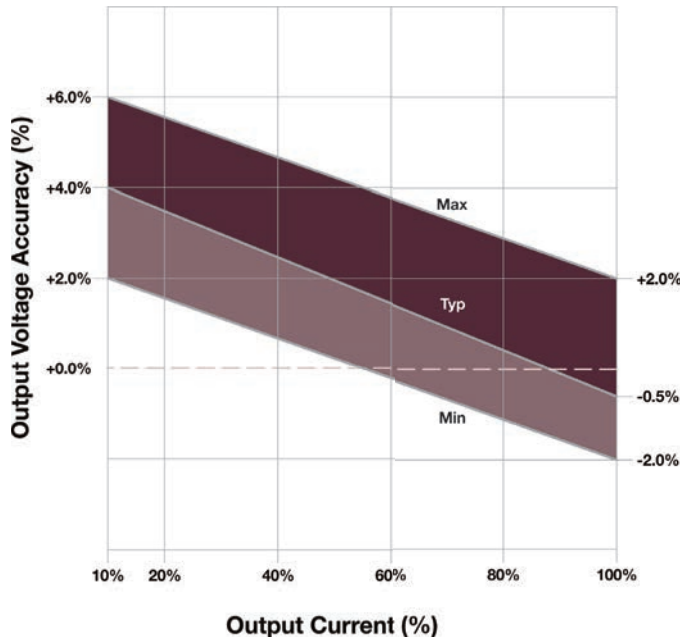

**Output Voltage Tolerance: Negative Output**

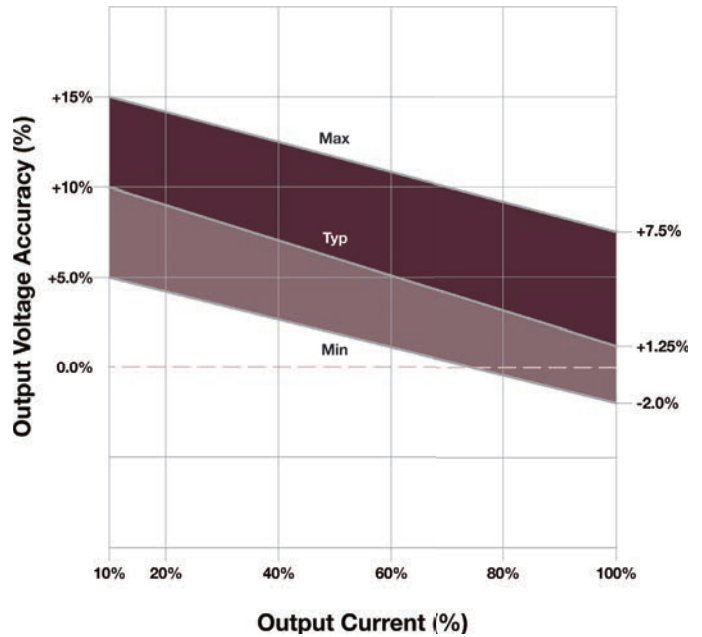

## Typical Connection

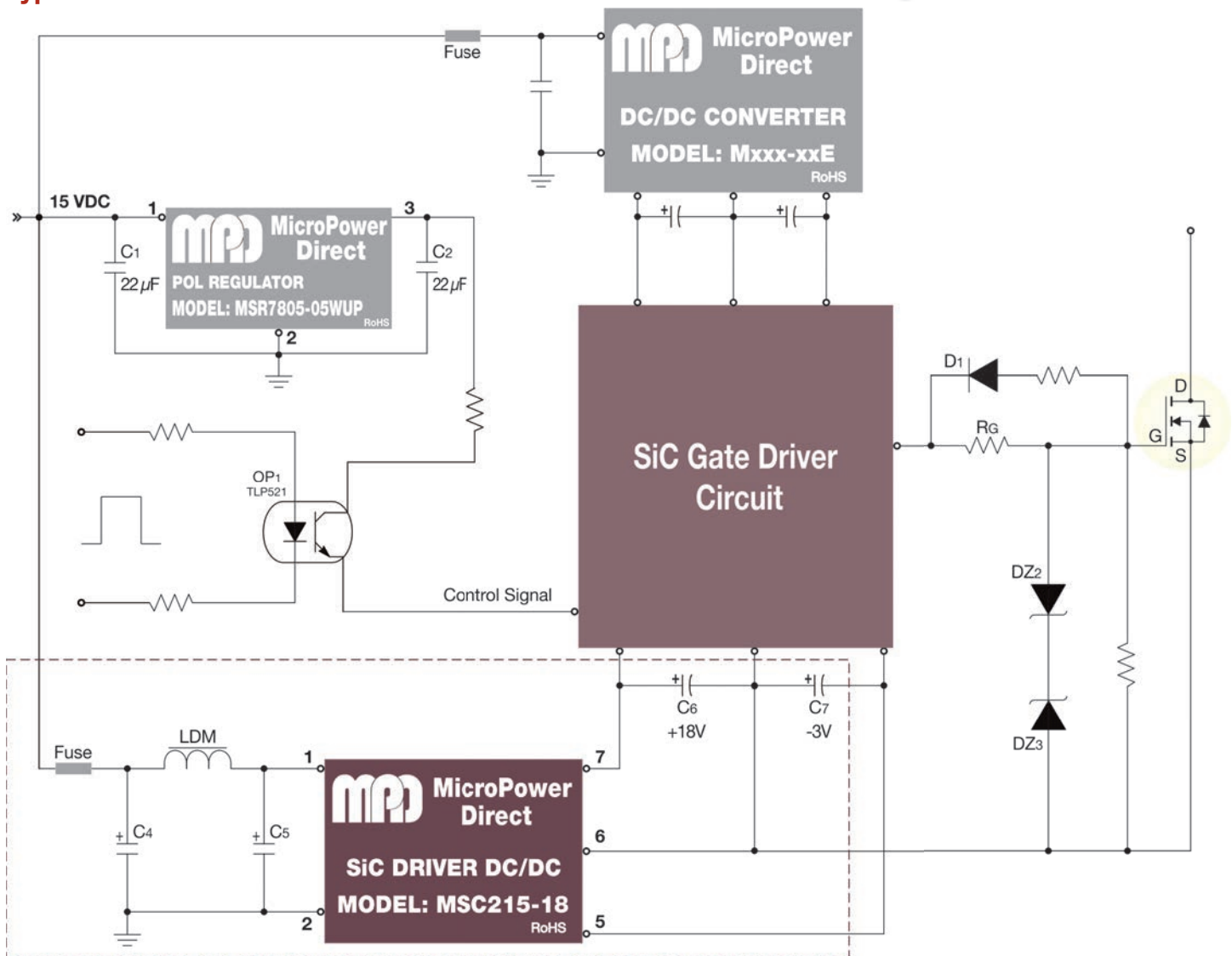

The **MSC215-18** is specifically designed for use in gate driver circuits. With asymmetrical outputs of +18 VDC & -3 VDC, an isolation barrier specified at 3.5 kVAC, very low isolation capacitance and a wide operating temperature range; they are an ideal choice for Silicon Carbide (SiC) MOSFET drive & control circuits.

SiC MOSFETs are often used in high voltage, very high frequency applications. The figure above illustrates a typical connection to a driver circuit. Again, **MPD** offers a number of power products that can be used in gate driver circuits (IGBT and SiC).

The circuit above uses three **MPD** parts. At the top, a DC/DC converter is used convert the system 15 VDC bus into voltage levels required by the driver components (if required). This converter also isolates the driver circuit from the power bus. **MPD** offers hundreds of standard DC/DC converters that can be used for this purpose.

The **MSR7805-05WUP** is a miniature, very low cost switching regulator. In this circuit, it converts the 15 VDC bus into a regulated 5 VDC that is used for the input signal pull-up.

The **MSC215-18** converts the input 15 VDC into asymmetrical +18 VDC & -3 VDC outputs. These outputs are used to set up the positive/minus gate bias required for high and low side switching.

The **MSC215-18** also provides power isolation for the gate drive. All models are specified for 3.5 kVAC I/O isolation. The optocoupler provides isolation for the control signal.

Some notes on the **MSC215-18** connection (starting with the input) are:

1. The **MSC215-18** DC/DC should be mounted as close to the SiC driver circuit as possible, to minimize the length of connecting board traces or wires.
2. The **MSC215-18** does not include overload protection (typical of most low power DC/DC's). It is recommended that an external fuse be used. The recommended fuse is shown in the model chart on page two.
3. The addition of the input filter components (C4, C5 and LDM) will typically bring the **MSC215-18** circuit to within the limits of EN 55022 Class B. The recommended values for these components are shown in the table at right.

If meeting EN 55022 class A or B is not a concern, the inductor (LDM) and one capacitor (C4) can be eliminated.

4. The recommended values for the decoupling capacitors C6 and C7 are shown in the table below. These low ESR capacitors should be mounted as close to the driver circuit as possible.
5. If used, input filtering components (C4, C5 and LDM) should be mounted as close to the **MSC215-18** as possible. The PC board trace (or wire) between the DC/DC and the driver circuit should be as short as possible.
6. The use of tantalum capacitors in this circuit should be avoided.
7. Recommended values for components are:

Component	Value
C4	4.7 $\mu$ F/50V
LDM	6.8 $\mu$ H
C5	4.7 $\mu$ F/50V
C6	100 $\mu$ F/35V
C7	100 $\mu$ F/35V

## Mechanical Dimensions

www.micropowerdirect.com

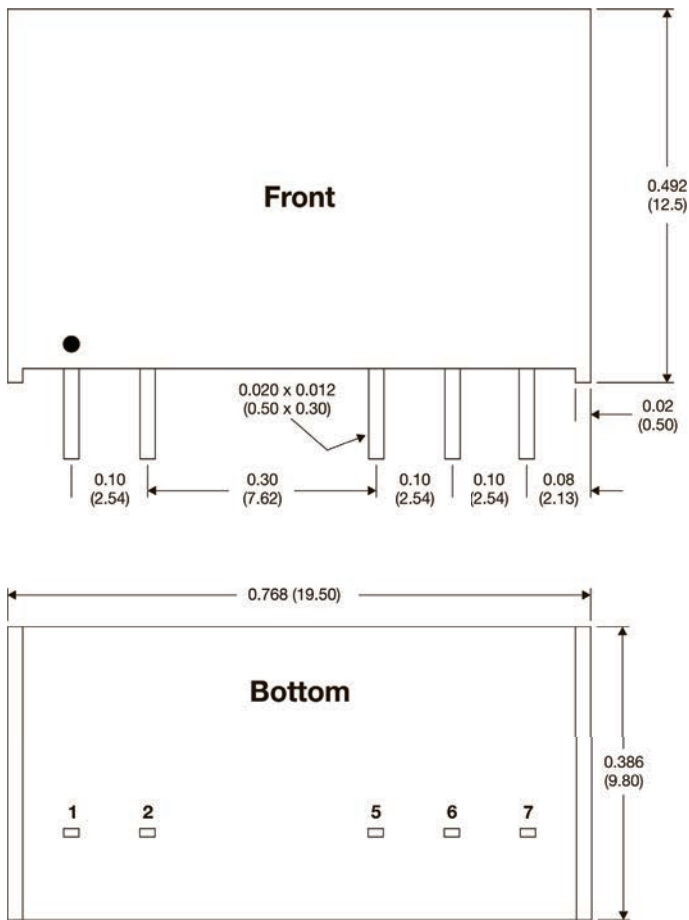

## Pin Connections

Pin	Function
1	+VIN
2	Gnd
5	-VOUT
6	Common
7	+VOUT

### Notes:

- All dimensions are typical in inches (mm)
- Pin Tolerance x.xxx =  $\pm 0.004$  ( $\pm 0.10$ )
- General Tolerance x.xx =  $\pm 0.010$  ( $\pm 0.25$ )
- Pin 1 is marked by a "dot" or indentation on the unit

MPD offers a very wide range of products specifically designed for use in high power, high speed gate drive circuits. Products include miniature DC/DC converters with asymmetrical outputs that fit the specific requirements of IGBT and SiC semiconductors. Also available are IGBT driver circuits that include much of the control circuit in a small SIP package. For full information, go to our website or contact the factory.

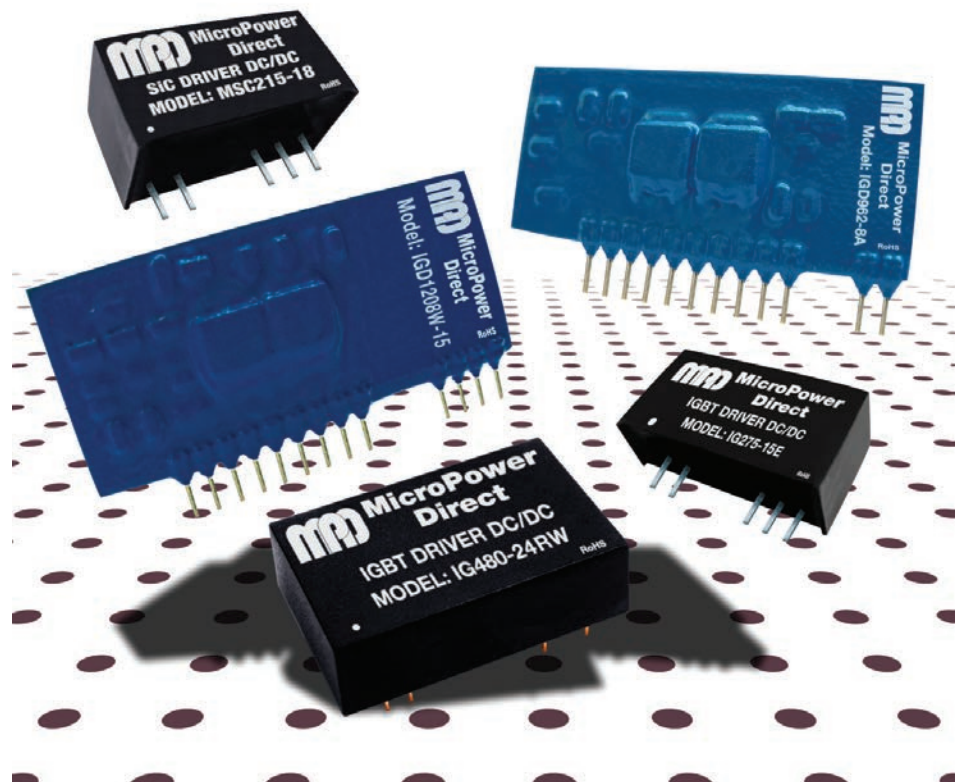

# MicroPower Direct

**We Power Your Success - For Less!**

292 Page Street Ste D Stoughton, MA 02072 • TEL: (781) 344-8226 • FAX: (781) 344-8481 • E-Mail: sales@micropowerdirect.com